



# Profile Design Recommendations

# Profiled Belts – Design Recommendations

Over one thousand profile designs are available from Gates Mectrol’s extensive mold inventory. Visit the Gates Mectrol Profile Selector Guide at [www.gatesmectrol.com](http://www.gatesmectrol.com) to search our profile library. Our applications engineers can work with you to design any profile to meet your specific requirements. Tooling charges are minimal for most customized designs.

Although it is possible to have nearly any design utilizing welded profiles, ultimate performance for your application can be achieved by following the design guidelines outlined below:

## 1. Profile Spacing

It is recommended that the profile spacing, A, correspond with the pitch of the belt teeth. This allows for the best spacing tolerances, and minimizes the effects of the belt’s overall length tolerance on the profile spacing.

Profiles can be spaced on non-pitch increments. However, if non-pitch spacing is used, the cumulative tolerance of the belt length must be considered.

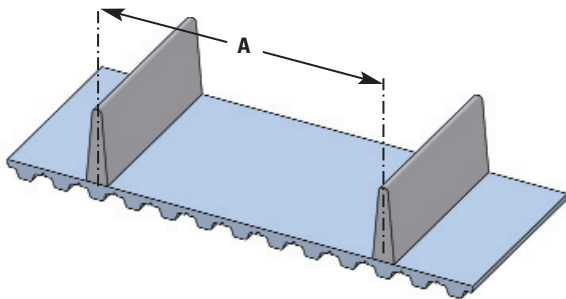

**Profile Spacing Tolerance**

Profile Spacing	Over Tooth Non-cumulative	Not Over Tooth
0.2" ≤ A < 1.0" 5 mm ≤ A < 25.4 mm	±0.015" ±0.38 mm	±0.020" ±0.5 mm
1.0" ≤ A < 9.0" 25.4 mm ≤ A < 228.6 mm	±0.020" ±0.5 mm	±0.025" ±0.6 mm
9.0" ≤ A < 18.0" 228.6 mm ≤ A < 457.2 mm	±0.025" ±0.6 mm	±0.030" ±0.8 mm
18.0" ≤ A < 27.0" 457.2 mm ≤ A < 685.8 mm	±0.030" ±0.8 mm	±0.035" ±0.9 mm
27.0" ≤ A < 36.0" 685.8 mm ≤ A < 914.4 mm	±0.035" ±0.9 mm	±0.040" ±1.0 mm

For spacing greater than 36.0", add 0.006" per ft.

For spacing greater than 914.4 mm, add 0.15 mm per 305 mm.

Tighter tolerances on profile spacing are available. Contact a Gates Mectrol Applications Engineer for more information.

## 2. Profile Dimensions

The most important considerations while dimensioning a profile are the size of the base of the profile (“foot” of the profile) and the position of the profile on the belt.

The profile thickness can affect the flexibility of the belt, and can determine the minimum allowable pulley diameter. The flexibility of the belt can be maximized, however, by positioning the profile directly over the tooth of the belt.

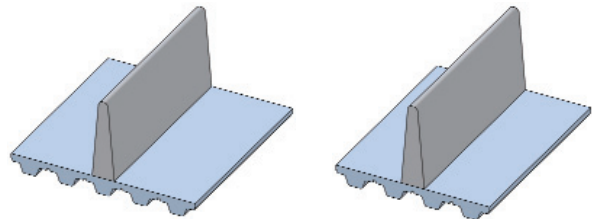

**Over Tooth**

**Not Over Tooth**

As the thickness of the foot of the profile increases, the minimum pulley diameter in the system must be increased according to the table on the next page.

The molded tolerances of the profile itself i.e. thickness, height, length, etc. are controlled within ±.010". The installed height tolerance of a profile is typically +.010", –.020".

*Gates Mectrol Applications Engineers will assist in all regards where tolerances are an issue. Please contact: [apps@gatesmectrol.com](mailto:apps@gatesmectrol.com).*

*To access all of our standard profiles visit the Profile Selector Guide at [www.gatesmectrol.com](http://www.gatesmectrol.com).*



# Profiled Belts – Design Recommendations

Minimum Number of Pulley Teeth For Profiles Over a Tooth\*

Profile "Foot" Thickness	Inch mm	1/16 1.60	1/8 3.00	3/16 5.00	1/4 6.00	5/16 8.00	3/8 10.00	7/16 11.00	1/2 13.00	5/8 16.00	3/4 19.00
XL		10	10	18	25	40	50	60	100	N/R	N/R
L		12	12	12	18	30	40	50	60	100	N/R
H, H-HF		14	14	14	14	18	25	35	45	80	100
XH		18	18	18	18	18	18	18	20	35	50
T5		12	12	18	25	40	50	60	100	N/R	N/R
AT5, ATL5		15	15	18	25	40	50	60	100	N/R	N/R
T10, T10-HF		16	16	16	16	18	25	35	45	80	100
AT10		18	18	18	18	22	25	35	45	80	100
ATL10, ATL10-HF		25	25	25	25	25	25	35	45	80	100
T20, AT20		18	18	18	18	18	18	18	20	35	50
ATL20		30	30	30	30	30	30	30	30	35	50
HTD5, STD5		14	14	16	25	40	50	60	100	N/R	N/R
HTD8, STD8		20	20	20	24	30	40	50	60	100	N/R
HTD14		28	28	28	28	28	28	30	30	50	72
HTDL14		43	43	43	43	43	43	43	43	50	72

Minimum Number of Pulley Teeth For Profiles Not Over a Tooth\*

Profile "Foot" Thickness	Inch mm	1/16 1.60	1/8 3.00	3/16 5.00	1/4 6.00	5/16 8.00	3/8 10.00	7/16 11.00	1/2 13.00	5/8 16.00	3/4 19.00
XL		12	30	45	50	60	100	N/R	N/R	N/R	N/R
L		12	20	40	45	55	60	70	80	100	N/R
H, H-HF		14	14	25	30	45	50	55	65	80	100
XH		18	18	20	30	40	45	50	54	58	60
T5		12	30	45	50	60	100	N/R	N/R	N/R	N/R
AT5, ATL5		15	30	45	50	60	100	N/R	N/R	N/R	N/R
T10, T10-HF, AT10		18	20	30	40	45	50	55	65	80	100
ATL10, ATL10-HF		25	25	30	40	45	50	55	65	80	100
T20, AT20		18	18	20	30	40	45	50	54	58	60
ATL20		30	30	30	30	40	45	50	54	58	60
HTD5, STD5		18	30	45	50	60	100	N/R	N/R	N/R	N/R
HTD8, STD8		20	20	40	45	55	60	70	80	100	N/R
HTD14		28	28	30	42	58	64	72	78	82	86
HTDL14		43	43	43	43	58	64	72	78	82	86

\*Minimum number of pulley teeth must be equal to or greater than minimum shown in the appropriate Belt Specifications Table.

N/R = not recommended

## 3. Profile Strength

The strength, and therefore capacity of the profile, depends primarily on the size of the welded profile foot.

The strength of the profile is affected by the type and direction of the force applied to it. Under high loads, the failure mode will normally be either bending and distortion of the profile and belt, or in some cases, the polyurethane may actually tear.

With a load introduced against the profile at a point 1/4" above the belt surface, the strength of the profile is 2,500 lbs. per square inch of welded foot area, or 1724 N/cm<sup>2</sup>.

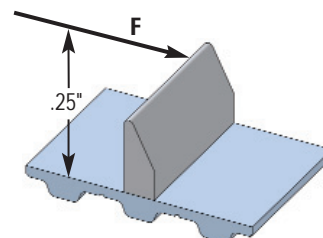

# Profiled Belts – Design Recommendations

## 4. Wide Base Profiles, and Profiles With Relief

For profiles requiring a wide base, such as pushers, one foot should be left unwelded. This allows for flexing around the pulley yet it remains rigid when loaded.

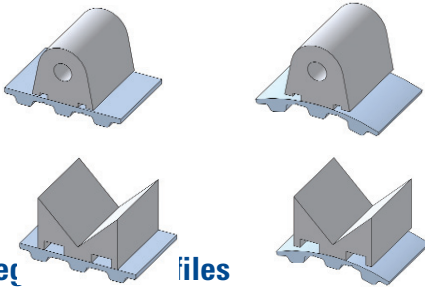

## 5. Segmented Profiles

When large profiles are required as carriers, they must be either segmented or slotted. This is necessary to allow flexing around the pulley. On the flat conveyor surface, the profiles remain intact.

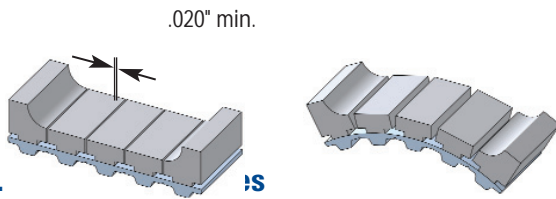

## 6. Profiles With Holes

Profiles with holes for securing paddles or other attachments can be produced. Holes are either drilled before bonding, or are molded into the profile depending upon the volume and requirements of the application.

Tolerances of the hole placement depends upon whether the holes are drilled or molded. The tolerance of the hole from the belt surface is subject to the bonding process of the profile foot and the belt surface.

Generally, tolerances are as shown below. However, tighter tolerances are possible. Please consult our Applications Engineering Department.

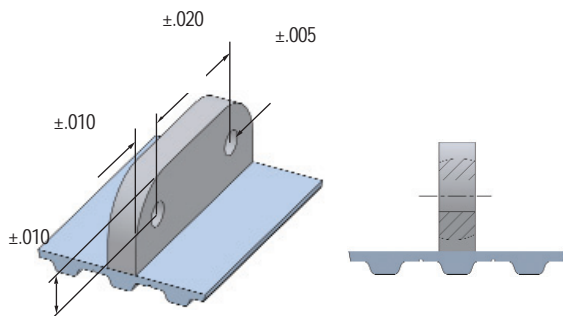

## 7. Profiles With Inserts

Profiles can be molded with metallic inserts. These are particularly useful in some applications to replace attachment chain.

The actual inserts can either be manufactured by Gates Mectrol or provided by the customer.

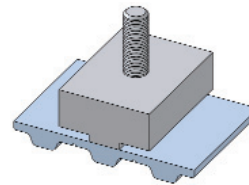

## 8. Flash Bead

During the welding process, a bead of urethane develops at the meeting point of the profile and belt.

The welding bead is removed, “de-flashed”, as necessary.

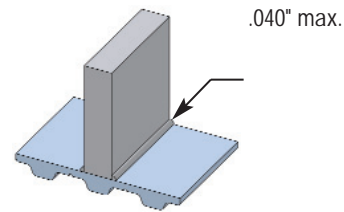

## 9. Perpendicularity

All profiles are perpendicular to 1°.

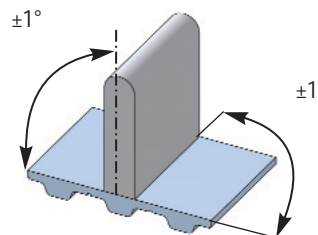

## 10. Ordering

When ordering a profiled belt, it is advisable to submit a drawing of the profiled belt.

Once a design is finalized, Gates Mectrol will submit a drawing to the customer for approval. This custom belt drawing number should then be used for future ordering.



**GATES MECTROL, INC.**

9 Northwestern Drive  
Salem, NH 03079, U.S.A.

Tel. +1 (603) 890-1515

Tel. +1 (800) 394-4844

Fax +1 (603) 890-1616

email: [apps@gatesmectrol.com](mailto:apps@gatesmectrol.com)

Gates Mectrol is a registered trademark of Gates Mectrol Incorporated. All other trademarks used herein are the property of their respective owners.

© Copyright 2010 Gates Mectrol Incorporated. All rights reserved. 11/10

GM\_Profile Design\_10\_US

[www.gatesmectrol.com](http://www.gatesmectrol.com)

---